

Contour 0036 Aluminum Profile



Profile designed to ensure that the LED source is invisible, offering uniform and soft lighting for the eyes. Compact and versatile design.

Features

- Delivered in standard 6.5 ft (2m) length.
- Available as factory assembled complete fixture. See page 3 for details.
- Designed to give a uniform light without hot spots.
- Its use increases the lifetime of your LED strip.
- Compatible with multiple installation accessories.
- Trimless application for new drywall construction.

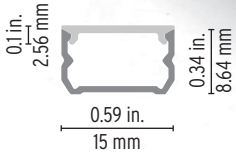

Project name _____







Fixture type _____ Phase _____

Specifier _____ Date _____

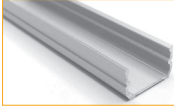

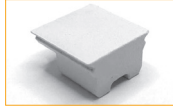
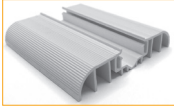
Cable Feed: End (E)
Max 4.7 W/ft

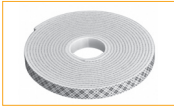
Order Code - Component

Family	Profile	Optic	Endcaps	Mounting
Contour	10000537-2m	12000055-2m	11000219-RAL9003	
	 Profile, Silver 10000537-2m	 Low Square, Opal 12000055-2m	 Low Square, White Aluminum 11000219-RAL9003	 Trimless Mounting Profile, PVC 10000580-W-2m  Mounting Dummy, 1m 10000573  Mounting Bracket, Metal 13000318  Adhesive Tape, 180 ft. 18200128

Technical Details

LOW SQUARE, OPAL

60% light efficiency



Lens Diffusion 100%
No CCT offset

Assembly Dimensions mm / in

WITH TRIMLESS MOUNTING PROFILE & LOW SQUARE OPAL

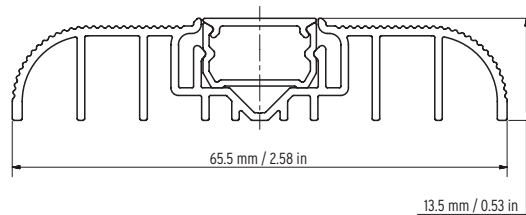

WITH MOUNTING BRACKET

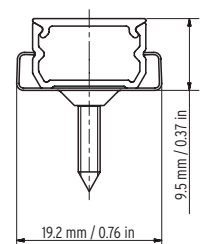

Order Code - Factory Assembled Fixture

Family	LED Tape Order Code	Profile Order Code ^A	Cable/Connector	Cable Position ^B	Custom Length (mm)	Ingress
VarioLED	Refer to LED Tape Spec Sheet	Refer to Profile Spec Sheet	A - Female and Male IP20 Connector (4 in) B - Male IP20 Connector on one side (4 in) C - Open end cable lead on both sides (6.5 ft) D - Open end lead on one side (6.5 ft)	E - Cables from end of fixture	Refer to Custom Length Calculation below	IP20

Example

VarioLED	Hydra HD15 W830	1210 1269 1280	A	B	1980	IP20
----------	-----------------	----------------	---	---	------	------

^A Do not need to specify endcaps. Factory assembled fixtures come with glued endcaps to match the selected optic, cable and connector configurations.

^B Some cable positions may not be available for certain models. See profile spec sheets for details.

Custom Length Calculation

- 1) Select your tape and desired length from the chart below.
- 2) Add 10mm to accommodate for wiring space inside profile. This defines the length of the aluminum profile.
- 3) Add 10mm to accommodate for endcap thickness if applicable. Note that endcap thickness may vary between different profile types by +/- 2mm which may result the fixture to be up to 4mm shorter.
- 4) Maximum Fixture length is 2000mm (6.5') for all models.

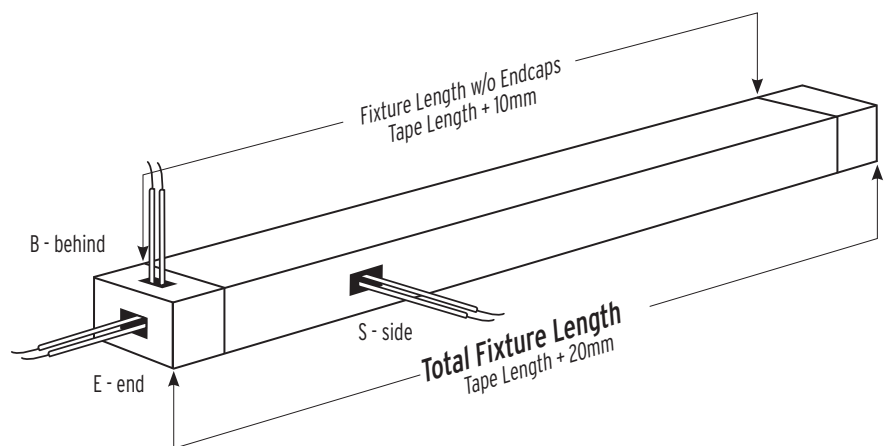

Tape Selection and Tape Length

	Min. Tape Length		Max. Tape Length		Tape Increment	
	inch	mm	inch	mm	inch	mm
Luminaris LD	2.76	70	77.17	1960	2.76	70
Luminaris HD	2.76	70	77.17	1960	2.76	70
Hydra LD	4.92	125	73.82	1875	4.92	125
Hydra HD	2.46	62.5	76.28	1938	2.46	62.5
Hydra LD Tunable White	4.92	125	73.82	1875	4.92	125
Hydra LD RGB	4.92	125	73.82	1875	4.92	125
Hydra HD RGB	2.46	62.5	76.28	1938	2.46	62.5
Nexus HD	2.46	62.5	76.28	1938	2.46	62.5
Nexus UHD	1.64	41.7	77.16	1960	1.64	41.7
Nexus HD Tunable White	2.46	62.5	76.28	1938	2.46	62.5
Sol LD	4.92	125	73.82	1875	4.92	125
Sol HD	2.46	62.5	76.28	1938	2.46	62.5
Sol LD Tunable White	9.84	250	68.90	1750	9.84	250
Static Color (Red/Green/Blue)	2.76	70	77.17	1960	2.76	70