

# VarioContour 0005 Aluminum Profile

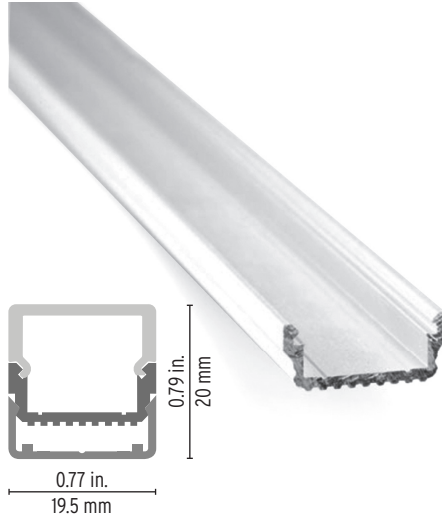

Designed for a variety of linear LED lighting needs. Different mounting options offer great flexibility for your linear application. The channel provides heat sink for low and medium power LED tapes where smaller installation heights are required. High light extraction efficacy and superior light quality.

### Features











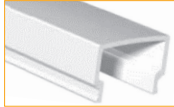

- Delivered in standard 6.5 ft (2m) length.
- Available as factory assembled complete fixture. See page 3 for details.
- Designed to give a uniform light without hot spots.
- Its use increases the lifetime of your LED strip.
- Compatible with multiple installation accessories.

Project name	
Fixture type	Phase
Specifier	Date

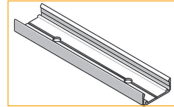

Cable Feed: Behind (B)  
Max 4.7 W/ft

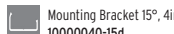
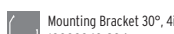
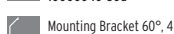
## Order Code - Component

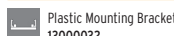
Family	Profile	Optic	Endcaps	Mounting
VarioContour	10000038		11000020	
				
				
				
				
				
				
				
				

## Technical Details

### Optic

HIGH SQUARE, OPAL

ROUND, OPAL

80% efficiency

80% efficiency

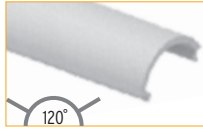
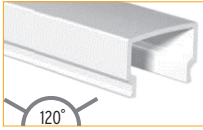

Diffusion 100%  
CCT offset -215 Kelvin

Diffusion 100%  
CCT offset -215 Kelvin

### Assembly Dimensions in / mm

#### High Square Opal Optic

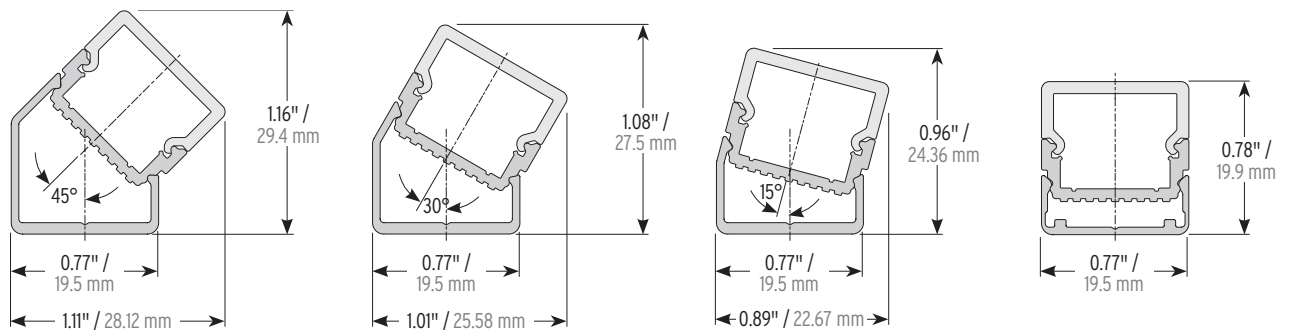

#### Round Opal Optic

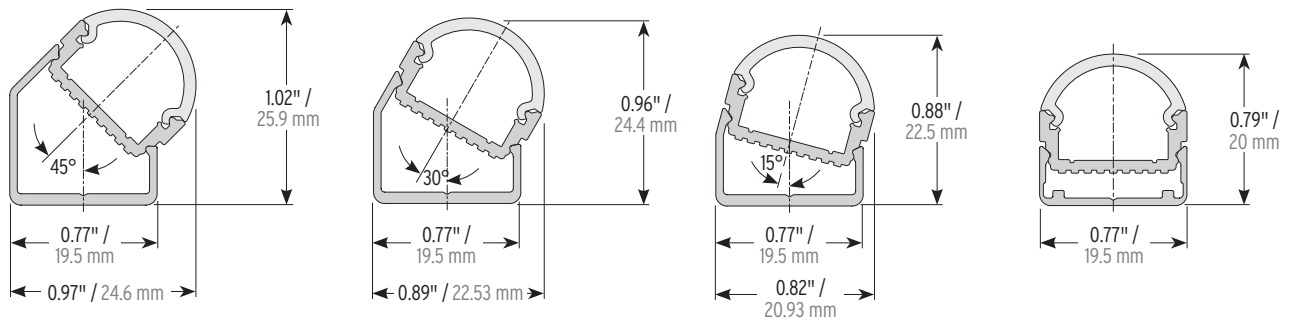

## Order Code - Factory Assembled Fixture

Family	LED Tape Order Code	Profile Component Order Code <sup>A</sup>	Cable/Connector	Cable Position <sup>B</sup>	Custom Length (mm)	Ingress
VarioLED	Refer to LED Tape Spec Sheet	Refer to Profile Spec Sheet (Page 1)	<b>A</b> - Female and Male IP20 Connector (4 in) <b>B</b> - Male IP20 Connector on one side (4 in) <b>C</b> - Open end cable lead on both sides (2 ft) <b>D</b> - Open end lead on one side (2 ft)	B - Cables from behind fixture	Refer to Custom Tape Length Chart Below (insert L)	IP20

### Example

VarioLED	Hydra HD15 W830	1200 1269 1280	A	B	1969	IP20
----------	-----------------	----------------	---	---	------	------

### Custom Length (L)

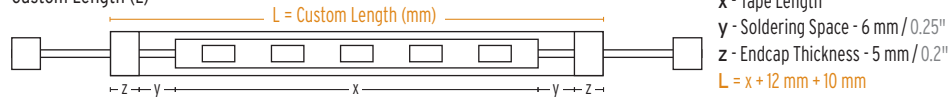

### Cable Position

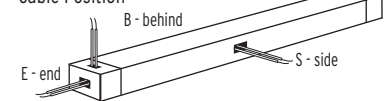

Tape Length (x) Chart <sup>C,D</sup>	Min. Tape Length	Max. Tape Length	Tape Increment
Luminaris LD	70 mm / 2.76"	1970 mm / 77.56"	70 mm / 2.76"
Luminaris HD	70 mm / 2.76"	1970 mm / 77.56"	70 mm / 2.76"
Hydra LD	125 mm / 4.92"	1885 mm / 74.21"	125 mm / 4.92"
Hydra HD	62.5 mm / 2.46"	1947 mm / 76.67"	62.5 mm / 2.46"
Hydra LD Tunable White	125 mm / 4.92"	1885 mm / 74.21"	125 mm / 4.92"
Hydra LD RGB	125 mm / 4.92"	1885 mm / 74.21"	125 mm / 4.92"
Hydra HD RGB	62.5 mm / 2.46"	1947 mm / 76.67"	62.5 mm / 2.46"

<sup>A</sup> Do not need to specify endcaps. Factory assembled fixtures come with endcaps to match the selected optic, cable and connector configurations.

<sup>B</sup> Some cable positions may not be available for certain models. See profile spec sheets for details.

<sup>C</sup> Maximum fixture length is 6.5 ft (2m) for all models.

<sup>D</sup> For custom fixture length, add 5 mm / 0.2" for each endcap thickness and 6 mm / 0.25" for soldering space.