

Contour 1500 Aluminum Profile

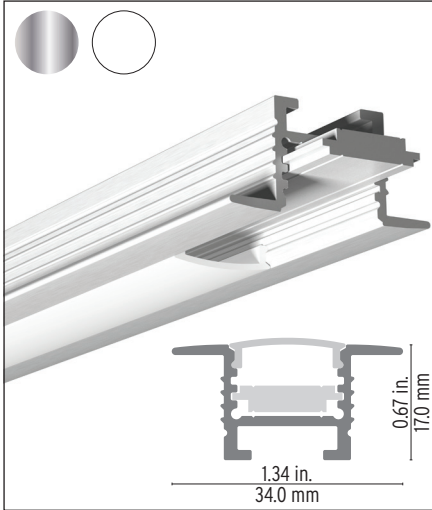

The design of the 1500 profile harmonizes with your décor and allows for a very secure recessed installation. It also permits adjusting the beam and provides comfortable lighting.

Features

- Delivered in standard 6.5 ft (2m) length.
- The support rail offers the largest range of installation and assembly.
- Designed to meet North American woodworking standards.
- Made of ALCOA 6063-T5 aluminum alloy increasing heat dissipation.
- Its use increases the lifetime of your LED strip.
- Compatible with multiple installation accessories.
- Only available in North America.

Project name _____

Fixture type _____ Phase _____











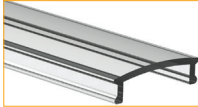





Specifier _____ Date _____

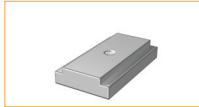

Linear weight:
0.2 lbs/ft (without optic)

Cable Feed: Behind (B)
Max 6.7 W/ft (with heatsink insert)

Component Order Code

Family	Profile	Optic	Endcaps	Mounting	Accessories
Contour			1571		
	 Profile, Silver 1500	 Clear 1269	 Endcap, Alu 1571	 Flat Mounting Clip 1280	 Heatsink Insert, 3/4 in.* 1235
	 Profile, White 1502	 Spread 1265		 Phantom Clip 1290	 Straight Joiner Type B 1325
		 Semi-Opal 1261		 Magnet Kit 1316	 Horizontal 90° Joiner Type B 1326
		 Opal 1263		 Wall Support Clip, Silver 1318	 Vertical 90° Joiner Type B 1327
		 Prime 1266		 Spring Clip, Alu 1570	 Wire Cover Type B 8099

*Using this accessory may lead to visible dotting.

See next page →

Technical Details

CLEAR

96.5% light efficiency

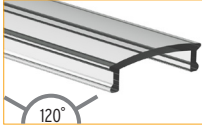

Visible dotting
CCT decrease 65 K

This basic lens protects your tape and maximizes light output.

SPREAD

95% light efficiency

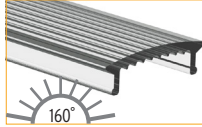

Visible dotting
CCT decrease 65 K

With its integrated prismatic grooves this lens scatters the light and increases the beam spread to better light nearby objects.

SEMI-OPAL

85% light efficiency

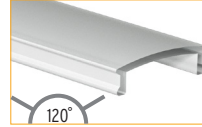

Slight Visible dotting
CCT decrease 130 K

This lens reduces glare and softens light cut-off while maintaining high brightness.

OPAL

50% light efficiency

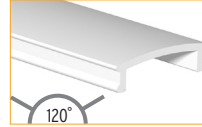

Dot free
CCT decrease 215 K

This lens provides dot free illumination and a homogenous line of light.

PRIME

85% light efficiency

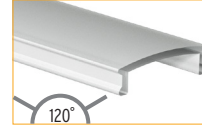

Dot free
CCT decrease 130 K

This lens reduces glare and softens light cut-off while maintaining high brightness.

Mounting Dimensions [mm] in



Phantom Clip

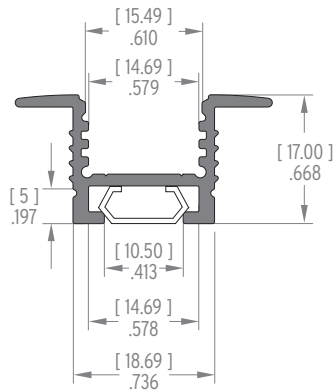

Magnet Kit

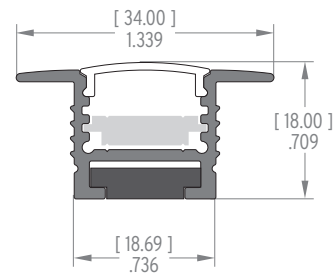

Spring Clip

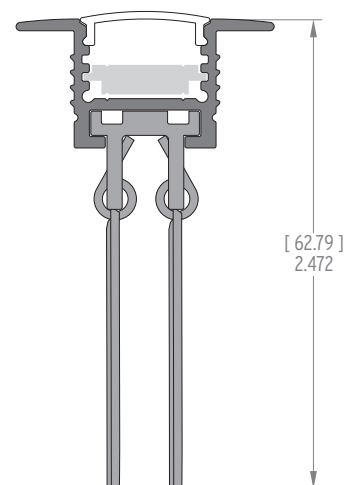
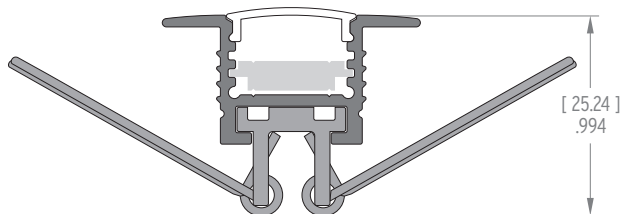

LED FLEX TAPE COMPATIBILITY CHART

✓ Compatible

✓ Dot free with Opal/Prime Lenses

LED Tape Family	LED Tape Type	Models ¹	LED Tape Step Length	Contour 1500 Compatibility
LUMINARIS	Static White	Luminaris LD05 (1.7w/ft, 152lm/ft)	2.76"/70mm	✓
		Luminaris LD10 (2.6w/ft, 311lm/ft)	2.76"/70mm	✓
		Luminaris LD15 (4.7w/ft, 463lm/ft)	2.76"/70mm	✓
		Luminaris LD22 (6.3w/ft, 659lm/ft)	2.76"/70mm	✓ ²
		Luminaris HD05 (1.6w/ft, 201lm/ft)	2.76"/70mm	✓
		Luminaris HD10 (2.6w/ft, 320lm/ft)	2.76"/70mm	✓
		Luminaris HD15 (4.7w/ft, 552lm/ft)	2.76"/70mm	✓
		Luminaris HD22 (6.3w/ft, 716lm/ft)	2.76"/70mm	✓ ²
HYDRA	Static White	Hydra LD05 (1.5w/ft, 145lm/ft)	4.92"/125mm	✓
		Hydra LD10 (3.1w/ft, 359lm/ft)	4.92"/125mm	✓
		Hydra LD15 (4.6w/ft, 575lm/ft)	4.92"/125mm	✓
		Hydra LD25 (7.6w/ft, 935lm/ft)	4.92"/125mm	
		Hydra LD40 (12w/ft, 1212lm/ft)	4.92"/125mm	
		Hydra HD06 (1.8w/ft, 173lm/ft)	2.46"/62.5mm	✓
		Hydra HD10 (3.1w/ft, 289lm/ft)	2.46"/62.5mm	✓
		Hydra HD15 (4.6w/ft, 575lm/ft)	2.46"/62.5mm	✓
		Hydra HD25 (7.6w/ft, 935lm/ft)	2.46"/62.5mm	
		Hydra HD36 (11w/ft, 1365lm/ft)	2.46"/62.5mm	
	Tunable White	Hydra Tunable LD25 (7.6w/ft, 503lm/ft)	4.92"/125mm	
	RGB	Hydra RGB LD15 (4.6w/ft, 127lm/ft)	4.92"/125mm	✓
		Hydra RGB HD10 (3.4w/ft, 102lm/ft)	2.46"/62.5mm	✓
Hydra RGB HD20 (6.7w/ft, 191lm/ft)		2.46"/62.5mm	✓ ²	
NEXUS	Static White	Nexus HD06 (1.8w/ft, 160lm/ft)	2.46"/62.5mm	✓
		Nexus HD10 (2.9w/ft, 260lm/ft)	2.46"/62.5mm	✓
		Nexus HD15 (4.7w/ft, 420lm/ft)	2.46"/62.5mm	✓
		Nexus HD25 (7.6w/ft, 690lm/ft)	2.46"/62.5mm	
		Nexus HD40 (12.2w/ft, 1120lm/ft)	2.46"/62.5mm	
		Nexus UHD15 (4.6w/ft, 410lm/ft)	1.64"/41.7mm	✓
	Nexus UHD25 (7.6w/ft, 680lm/ft)	1.64"/41.7mm		
	Tunable White	Nexus Tunable HD12 (3.9w/ft, 190lm/ft)	2.46"/62.5mm	✓
		Nexus Tunable HD24 (7.3w/ft, 410lm/ft)	2.46"/62.5mm	
		Nexus Tunable HD42 (12.8w/ft, 770lm/ft)	2.46"/62.5mm	
SOL	Static White	Sol LD15 (4.7w/ft, 480lm/ft)	4.92"/125mm	✓
		Sol LD25 (7.6w/ft, 780lm/ft)	4.92"/125mm	
		Sol HD15 (4.7w/ft, 480lm/ft)	2.46"/62.5mm	✓
		Sol HD25 (7.6w/ft, 780lm/ft)	2.46"/62.5mm	
	Sol HD36 (11w/ft, 1160lm/ft)	2.46"/62.5mm		
Tunable White	Sol Tunable LD20 (6w/ft, 410lm/ft)	9.84"/250mm	✓ ²	
STATIC COLOR	Static Color	Static Color HD (3.1w/ft, 300lm/ft)	2.76"/70mm	✓

1) Lumen values reflect measurements of LED tape at 3000K. Tunable White, RGB and Static Color represent the highest possible lumen output.

2) Compatible when used with heatsink insert accessory.

Click for more information

LED FLEX TAPE

PROFILES & OPTICS

DRIVERS & CONTROLLERS