

CONSTANT VOLTAGE Non-Dimmable Led Driver

MODEL: D-REM-096W-NDM-UNV-IP65



Constant Voltage Class 2 LED Drivers from LED Linear offer a UL Listed style enclosure style enclosure that has a built-in junction box on both the input and output. These drivers are IP65 rated and are suitable for both indoor and outdoor installations. With universal input voltage ranging from 120 to 277VAC, this series of drivers are designed for commercial, industrial and residential applications.

Quick Specs

Input Voltage	Max Output Power	Output Voltage	Output Current	Efficiency @ Max Load	THD @ Max Load	Power Factor @ Max Load	Envir. Protection Rating
120-277VAC	96W	24VDC	4100mA	> 87%	< 20%	> 0.9	IP65

Features

- UL Listed Enclosure - With Built-In Junction Boxes
- Universal Input Voltage
- Ripple Free
- IP65 - For Both Indoor and Outdoor Use
- No Minimum Load Requirement
- UL 8750 Approved
- Class 2, Class P
- Auto-Reset Protection for Short Circuit & Over-Temperature
- Over Load Protection - CC Mode

Wiring Diagram

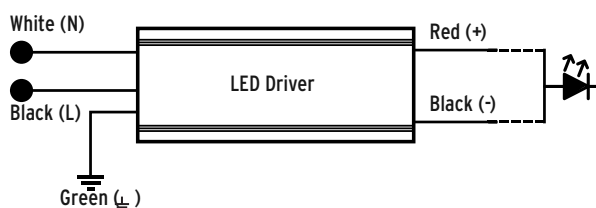

Technical Details - Constant Voltage LED Drivers

Input	Input Voltage Range	120 - 277VAC ± 10%
	Input Frequency	50 / 60Hz
	Input current	0.96A Max
	Inrush Current	5A Max @ 120V / 30A Max @ 277V Complies to NEMA 410
	Efficiency	> 87% Max
	Power Factor	> 0.95
	THD	< 20%
	Output	Output Voltage
Output Current		4100mA Max
Output Ripple		> 3%
Line Regulation		> 2%
Load Regulation		> 3%
Turn On Delay Time		> 0.3 Sec
Environmental Specification		Env. Protection Rating
	Operating Ambient temperature	-25°C - +40°C
	Max Case Temp. (Tcase)	80°C
	Storage temperature	-40°C - +85°C
	Expected life time	50K Hours (> 65°C) Tc
	Audible Noise	> 24db Class A
Protections Specification	Over Current Protection	Yes
	Over Voltage Protection	Yes
	Over Temperature Protection	Yes; Hiccup mode
	Over Load Protection	Yes; Current limit
	Short Circuit Protection	Yes; Current limit

Enclosure Details (mm)

Length	11.4 (290.5)
Mounting Length	12.1 (307.9)
Width	2.36 (59.9)
Height	1.4 (35)
Driver Weight	30.95oz (878gram)

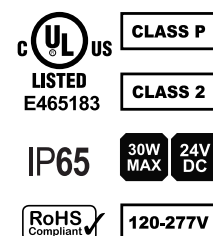

MODEL: D-REM-096W-NDM-UNV-IP65

Mechanical Details

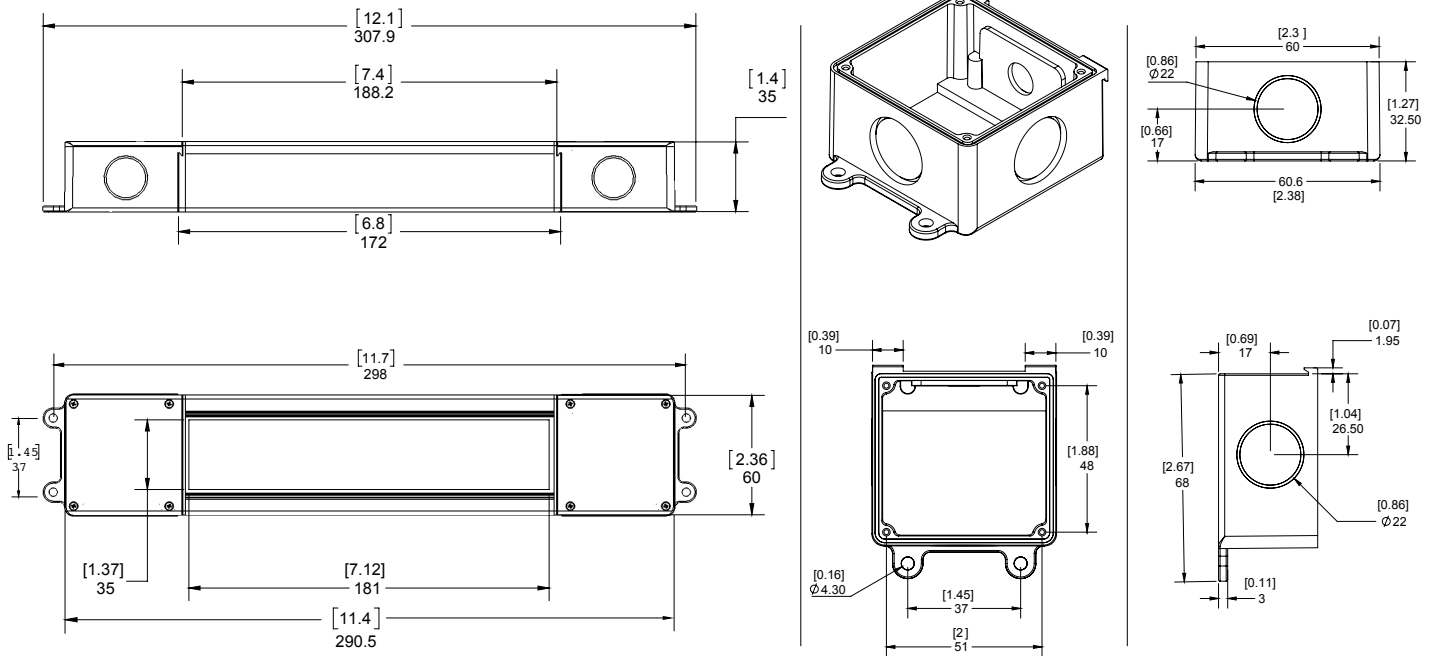

Efficiency vs Load

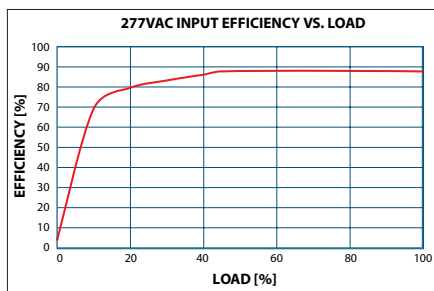
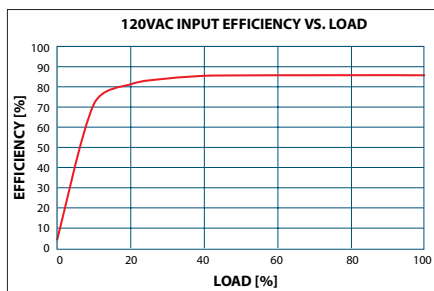

Flicker Performance

The IEEE P1789 flicker test results are presented with no observable effect (in green) low-risk (in yellow) and high risk (in red).

