

CONSTANT VOLTAGE 0-10V Dimmable Led Driver

LED LINEAR™
lighting solutions

Member of the
Fagerhult Group

MODEL: D-REM-060W-DIM-UNV-IP65



Constant Voltage Class 2 LED Drivers from LED Linear offer a UL Listed style enclosure that has a built-in junction box on both the input and output. These drivers are IP65 rated and are suitable for both indoor and outdoor installations. With universal input voltage ranging from 120 to 277VAC, this series of drivers are designed for commercial, industrial and residential applications. Our 0-10V dimming delivers smooth flicker-free linear dimming down to 1% with most LED's and a wide variety of compatible dimmers.

Quick Specs

Input Voltage	Max Output Power	Output Voltage	Output Current	Efficiency @ Max Load	THD @ Max Load	Power Factor @ Max Load	Envir. Protection Rating
120-277VAC	60W	24VDC	2600mA	> 87%	< 20%	> 0.9	IP65

Features

- UL Listed Enclosure - With Built-In Junction Boxes
- Universal Input Voltage
- 0-10V Dimmable - Flicker Free Down to 1%
- Ripple Free
- IP65 - For Both Indoor and Outdoor Use
- No Minimum Load Requirement
- UL 8750 Approved
- Class 2, Class P
- Auto-Reset Protection for Short Circuit & Over-Temperature
- Over Load Protection - CC Mode

Wiring Diagram

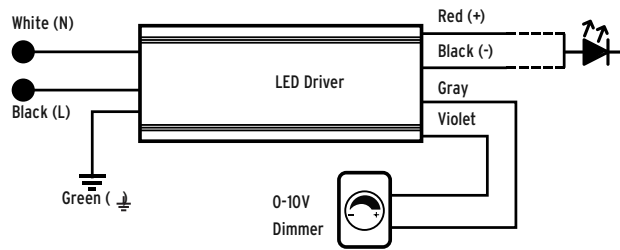

Technical Details - Constant Voltage LED Drivers

Input	Input Voltage Range	120 - 277VAC ± 10%
	Input Frequency	50 / 60Hz
	Input current	0.96A Max
	Inrush Current	5A Max @ 120V / 30A Max @ 277V Complies to NEMA 410
	Efficiency	> 87% Max
	Power Factor	> 0.95
	THD	< 20%
Output	Output Voltage	24VDC
	Output Current	1300mA Max
	Output Ripple	> 3%
	Line Regulation	> 2%
	Load Regulation	> 3%
	Turn On Delay Time	> 0.3 Sec
	Environmental Specification	Env. Protection Rating
Operating Ambient temperature		-25°C - +40°C
Max Case Temp. (Tcase)		80°C
Storage temperature		-40°C - +85°C
Expected life time		50K Hours (> 65°C) Tc
Audible Noise		> 24db Class A
Dimming	Dimming Control	0-10V
	Min. Dimming Level	1%
	Dimming Curves	Linear
	Current Consumption	0.2mA Max Source / Sinc
Protections Specification	Over Current Protection	Yes
	Over Voltage Protection	Yes
	Over Temperature Protection	Yes; Hiccup mode
	Over Load Protection	Yes; Current limit
	Short Circuit Protection	Yes; Current limit

Enclosure Details (mm)

Length	11.4 (290.5)
Mounting Length	12.1 (307.9)
Width	2.36 (59.9)
Height	1.4 (35)
Driver Weight	30.95oz (878gram)

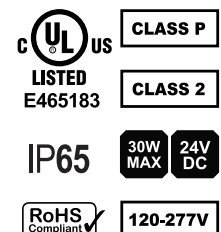

MODEL: D-REM-060W-DIM-UNV-IP65

Mechanical Details

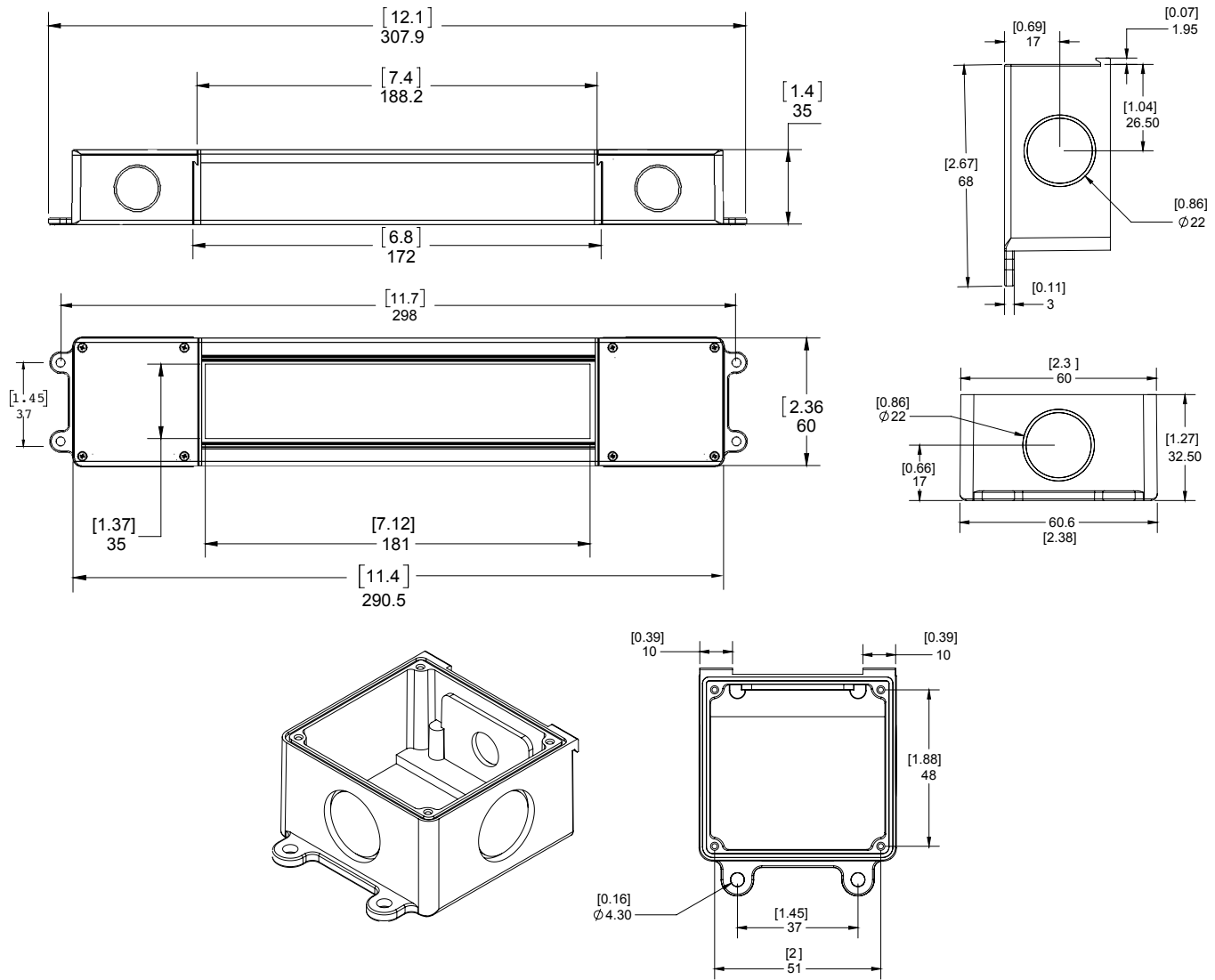

Efficiency vs Load

120VAC INPUT EFFICIENCY VS. LOAD

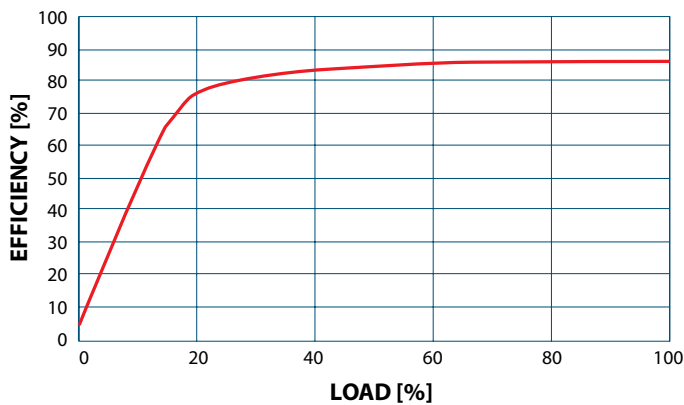

277VAC INPUT EFFICIENCY VS. LOAD

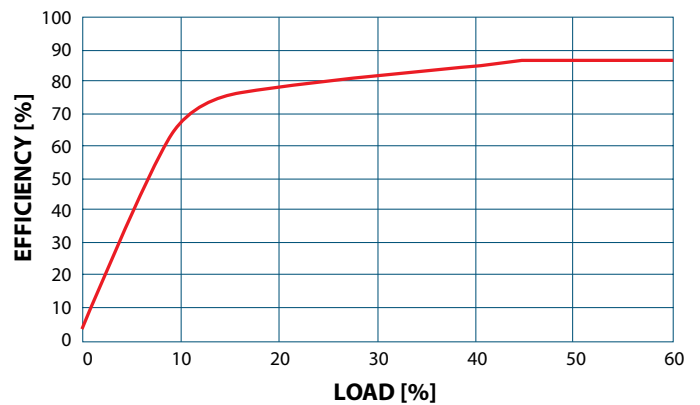

MODEL: D-REM-060W-DIM-UNV-IP65

Flicker Performance

The IEEE P1789 flicker test results are presented with no observable effect (in green) low-risk (in yellow) and high risk (in red).

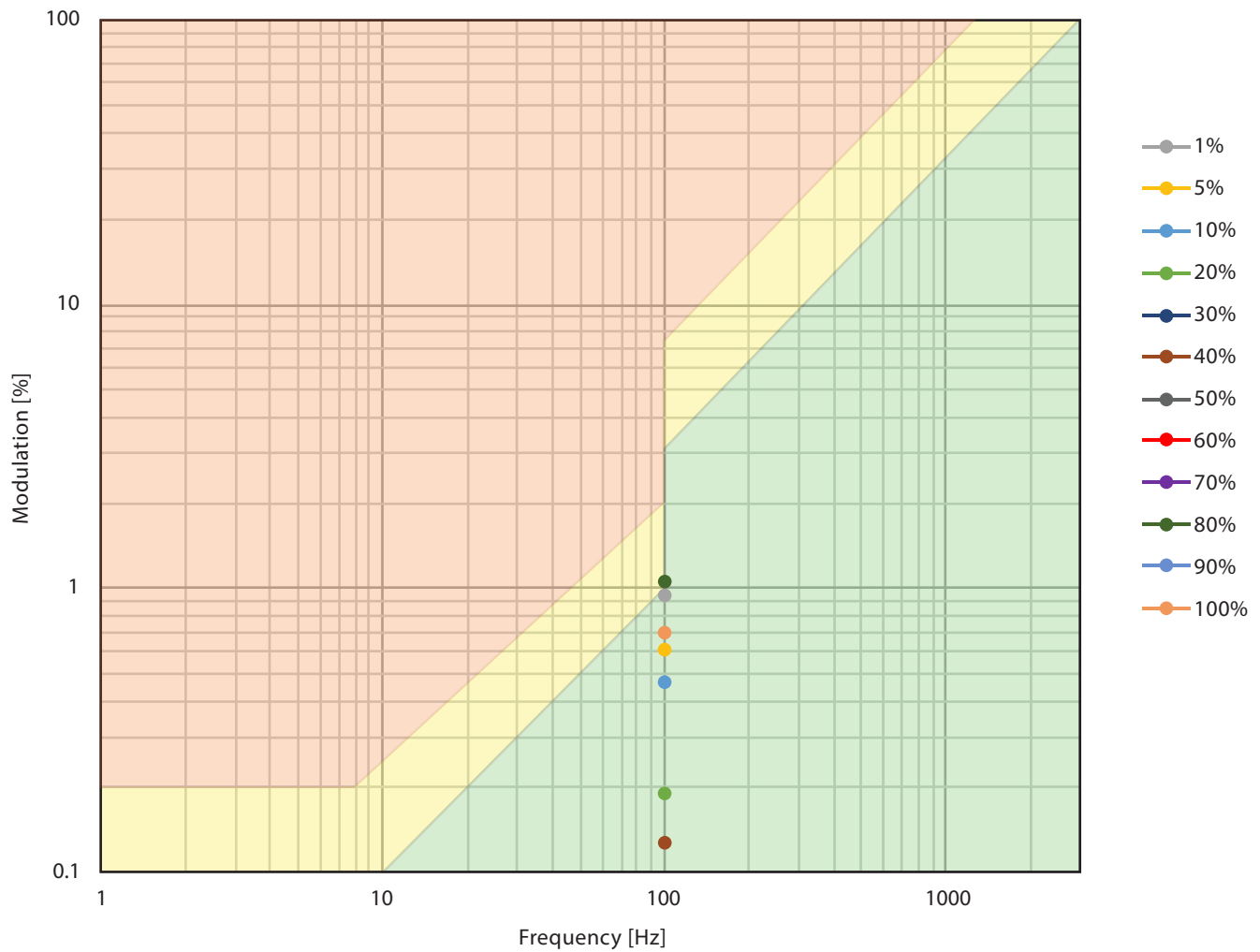

Output Power and Dimming

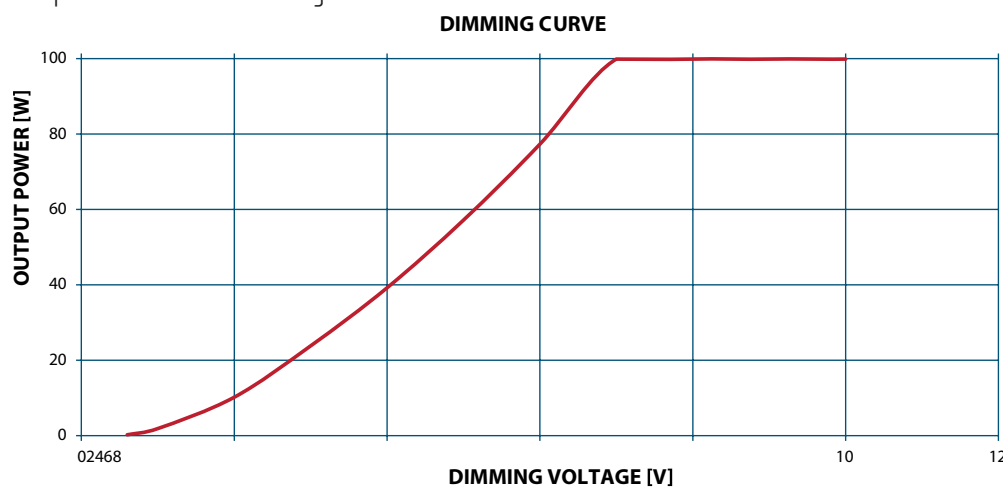

Compatible 0-10 Dimmer List

Dimming	Part Number
Lutron	Divya - DDTV
Lutron	Divya - NDTV
Lutron	Nova T - NTFTV
Leviton	illumatech - IP7
Watt Stopper	DCLV1
Lightolier Controls	ZP600FAM120
Phillips	Sunrise - SR1200ZTUNV