

XOOLIGHT Static White

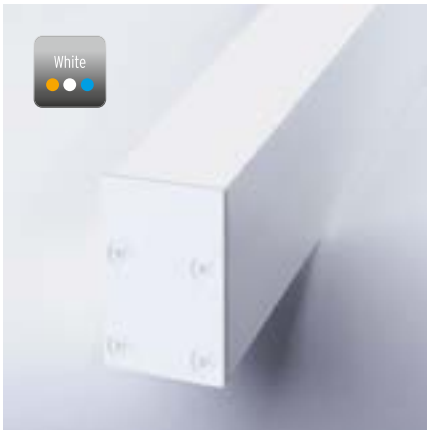

24 V linear LED luminaire in IP40 for general lighting. Robust 42 mm x 62 mm (1.65" x 2.44") cross section housing made from extruded and anodized aluminum profile and screwed aluminum end caps available in silver or white (white powder coated) color as recessed, surface-mounted or pendant version. Delivered with 2 m (6.56') open end black cable. Allows the use of 3 diffuser optics ideal for general lighting applications. Light source assembled using state of the art automated Reel to Reel (R2R) production process supporting LED Linear™ Tj Away® thin flexible circuit board technology. In combination with ceramic LED packages a thermal resistivity of 18.5 K/W is achieved for an optimal heat dissipation (junction to profile) which guarantees an outstanding lifetime of > 50,000 hrs L80/B10. Embeds high

quality Japanese LEDs with 3 step MacAdams (SDCM3) binning centered on target CCT (One Bin Only) with an extended photometric code of Wxxx/339 ensuring an exceptional color consistency over the rated lifetime. Premium color rendition with a CRI of 95 and TM-30-15 up to $R_i = 91 / R_g = 100$ ensuring a remarkable light quality. Consistent light intensity all along the luminaire length is obtained thanks to active current regulation operated by dedicated integrated circuits (ICs) on each step. Protected against electrostatic discharge $\pm 2,000$ V and polarity miswiring. Fully PWM dimmable for frequency > 0 Hz up to 2 kHz (flicker free for frequency higher than 1.2 kHz according to IEEE P1789 standard). Engineered and produced in Germany.

Dimensions & available lengths

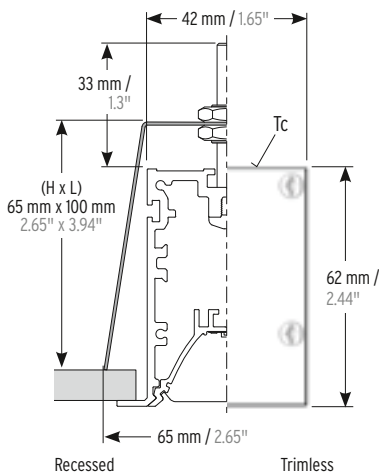

View rotated by 90°

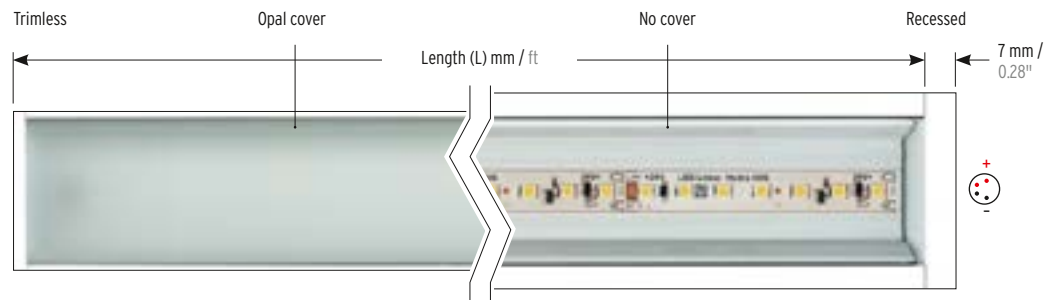

Recessed Trimless

Finish: Anodized Al-Silver/White powder coated

Tc-point (Case temp.) on the rear side of the module

Fixture build to length (not field cuttable):

L_{min} : 84 mm; L_{max} : 4,021 mm (HD25: 3,021 mm; HD36: 2,021 mm); in 62.5 mm increments
 L_{min} : 3.31"; L_{max} : 13.19" (HD25: 9.91"; HD36: 6.63"); in 2.46" increments

Electrical & output data

Voltage	24 Volt (23 V_{min} , 25 V_{max})				
Temperature ^c	$T_{c,min}$ = -25°C / -13°F, $T_{c,max}$ = specific, see Table below				
Storage temperature	$T_{s,min}$ = -30°C / -22°F, $T_{s,max}$ = 70°C / 158°F				
Ambient temperature	$T_{a,min}$ = -25°C / -13°F, $T_{a,max}$ = specific, see Table below				
CRI / R9	up to 95 / up to 65				

XOOLIGHT™ HYDRA	HD6	HD10	HD15	HD25	HD36
Power (W/m / W/ft) ^g	6 / 1.8	10 / 3.1	15 / 4.6	25 / 7.6	36 / 11
Efficacy (lm/W) ^g @ W850	100	100	106	104	105
max. length (m / ft)	4 / 13.1	4 / 13.1	4 / 13.1	3 / 9.8	2 / 6.6
Temperature Tc-point ($T_{c,max}$) ^c	55°C / 131°F	55°C / 131°F	55°C / 131°F	60°C / 140°F	70°C / 158°F
max. Ambient temperature ($T_{a,max}$)	50°C / 122°F	50°C / 122°F	50°C / 122°F	45°C / 113°F	35°C / 95°F

Color temperature		lumen/meter (lm/m) ^g lumen/feet (lm/ft) ^g @ Clear cover ^d				
		HD6	HD10	HD15	HD25	HD36
● W820	2,000 K	350 / 106	580 / 176	920 / 279	1,500 / 456	2,200 / 670
● W822	2,200 K	400 / 121	660 / 200	1,060 / 322	1,720 / 523	2,510 / 764
● W825	2,500 K	450 / 136	750 / 228	1,210 / 368	1,960 / 596	2,870 / 874
● W827	W927	400 / 121	670 / 203	1,280 / 389	2,080 / 633	3,040 / 926
● W830	W930	410 / 124	690 / 209	1,360 / 414	2,210 / 673	3,230 / 984
● W835	W935	420 / 127	710 / 215	1,430 / 435	2,320 / 706	3,390 / 1,032
● W840	W940	430 / 130	720 / 218	1,460 / 444	2,370 / 721	3,460 / 1,054
● W850	5,000 K	600 / 182	1,000 / 304	1,590 / 484	2,590 / 788	3,790 / 1,154

ONE BIN ONLY

LM 79 LM 79 compliant

LM 80 LM 80 compliant

Lifetime

L80/B10 > 50,000 h

Photo-metric code

Wxxx/339

Protection against granular objects > 1 mm / 0.034"

^a Without cover the IP protection level is reduced from IP40 to IP10.

^g The given data are typical values. Due to tolerances of the production process and the electrical components, values for light output and electrical power can vary up to 10%.

^c The Tc-point should be measured in thermal equilibrium according to IEC EN 60598-1.

^d Sample values. ! Note: ~40% luminous flux at opal and ~25% with diffuse cover.

Order code

Your order code	XOOLIGHT HYD	HD__	W__	__	__	__	__	__	__	IP__
Order code example	XOOLIGHT HYD	HD25	W8	27	1271	A	CL	BS	T	IP40

LED tape

HYDRA HD6	HD6
HYDRA HD10	HD10
HYDRA HD15	HD15
HYDRA HD25	HD25
HYDRA HD36	HD36

Color rendering

> 80	8
> 90 (only HD6, HD10)	9

Color temperature

2,000 K	20
2,200 K	22
2,500 K	25
2,700 K	27
3,000 K	30
3,500 K	35
4,000 K	40
5,000 K	50

Length

L_{min}: 84 mm (3.31"); L_{max}: 4,021 mm (13.19");
 HD25: 3,021 mm (9.91");
 HD36: 2,021 mm (6.63"); in 62.5 mm (2.46") increments

Housing material

Anodized Al-Silver	A
White powder coated	W

Cover options (DIN 5040:A50)

Without cover	X
Clear cover	CL
Diffuse cover	DI
Opal cover*	OP

Cable feed

Back side, 2 m / 6.56'	BS
Front side, 2 m / 6.56'	FS

Trim

Trimless	T
Recessed	R

Ingress Protection

IP10 (without cover)	IP10
IP40	IP40

*Dot free with HD LED tapes

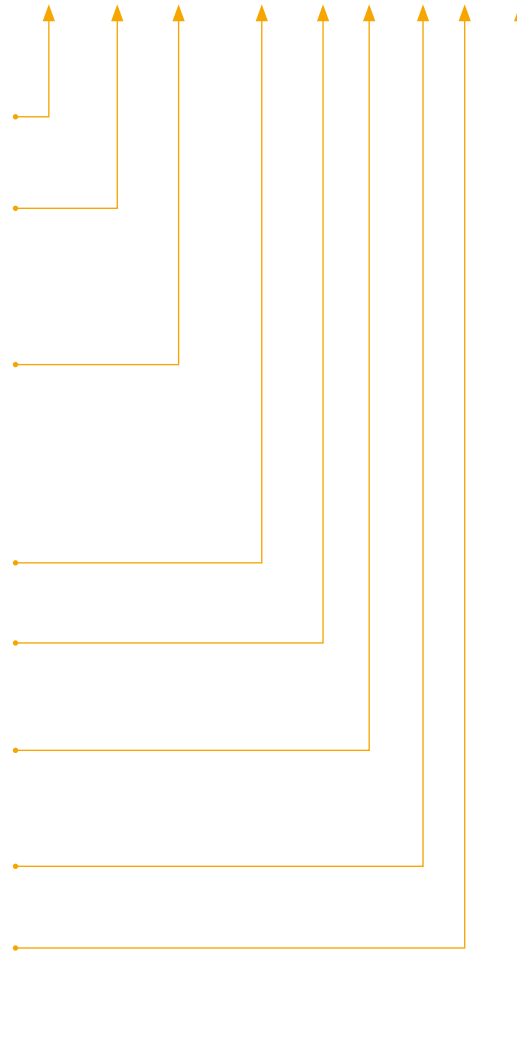

without cover[€]

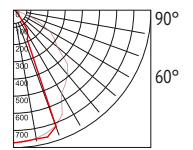

Clear cover[€]

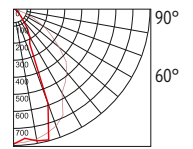

Diffuse cover[€]

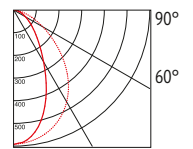

Opal cover[€]

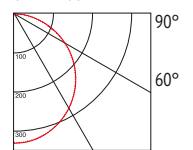

[€] DIN 5040:A50



Please choose your accessories



required

Recommended power supply	Art.-#
<input type="checkbox"/> Power Supply Unit IP20	16000178 

optional

Recommended control unit	Art.-#
<input type="checkbox"/> Control System White/IQ-White	16000268-DT6 

Pendant	Art.-#
<input type="checkbox"/> VarioPendant 4262	13000106 

Mounting clip recessed	Art.-#
<input type="checkbox"/> VarioClamp Contour 4262R	13000080 
<input checked="" type="checkbox"/> Continuous Mounting Connectors	10000321 

For actual data, further options and detailed information, please visit our website www.led-linear.com

VarioClamp

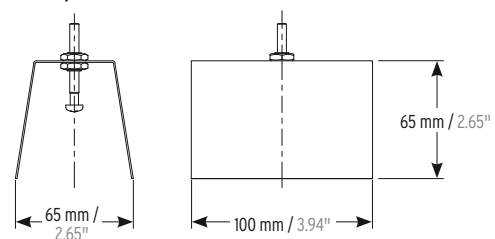

Mounting clip recessed

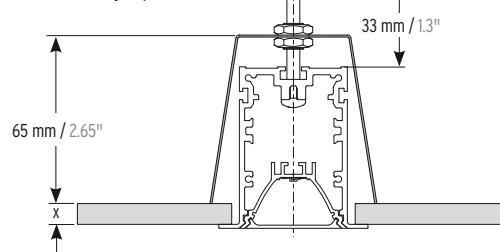

LED LINEAR

Drivers

Item	Specifications	Downloads
<p>LED LINEAR™ Non-Dimmable Drivers</p> 	<ul style="list-style-type: none"> • UL 8750 Listed Enclosure - With Built-In Junction Boxes • Universal Input Voltage 120V - 277V • IP65 - For Both Indoor and Outdoor Use • No Minimum Load Requirement • 24V Constant Voltage Output, Class 2 • Available in three wattages 30W, 60W and 96W • Max. Dimensions: 12-1/8" x 2-3/8" x 1-3/8" 	<p>30 W SPEC SHEET</p> <p>60 W SPEC SHEET</p> <p>96 W SPEC SHEET</p> <p>INSTALLATION INSTRUCTIONS</p>
<p>LED LINEAR™ 0-10V Dimmable Drivers</p> 	<ul style="list-style-type: none"> • UL 8750 Listed Enclosure - With Built-In Junction Boxes • 0-10V Dimmable - Flicker Free Down to 1% • Universal Input Voltage 120V - 277V • IP65 - For Both Indoor and Outdoor Use • 24V Constant Voltage Output, Class 2, Class P • Available in three wattages 30W, 60W and 96W • Max. Dimensions: 12-1/8" x 2-3/8" x 1-3/8" 	<p>30 W SPEC SHEET</p> <p>60 W SPEC SHEET</p> <p>96 W SPEC SHEET</p> <p>INSTALLATION INSTRUCTIONS</p>
<p>LED LINEAR™ ELV/Triac Dimmable Drivers</p> 	<ul style="list-style-type: none"> • UL 8750 Listed Class 2 Enclosure • 24V constant voltage output • Compact size yet high efficiency and performance in dry and damp environments (IP67) • Multiple Inputs: 120V or 277V • Fully dimmable: ELV Dimmers - Reverse or Adaptive Phase Control, Trailing Edge • Available in two wattages 48W and 96W • Multiple Circuits are available up to 4 units (up to 384W) 	<p>48 W SPEC SHEET</p> <p>96 W SPEC SHEET</p> <p>INSTALLATION INSTRUCTIONS</p>
<p>MW MEAN WELL PWM Dimmable Drivers</p> 	<ul style="list-style-type: none"> • Universal AC input / Full range (up to 305VAC) • Constant voltage PWM style output • Built-in 3 in 1 dimming function (0-10Vdc or PWM signal or resistance) • Dimming range : 0-100% • Class 2 power unit • Suitable for dry / damp / wet locations • UL Recognized component, 5 years warranty 	<p>40 W SPEC SHEET</p> <p>60 W SPEC SHEET</p> <p>90 W SPEC SHEET</p> <p>INSTALLATION INSTRUCTIONS</p>
<p>LUTRON Dimmable Drivers</p> 	<ul style="list-style-type: none"> • UL Listed Enclosure • Dimming Range: 100% to 1% and 0.1% (Premiere) • LED lighting turns on to any dimmed level without flashing to full brightness • Operating Voltage: 120V~ to 277V~ at 50/60 Hz • Rated lifetime of 50,000 hours at 40°C (104°F) ambient temperature and maximum loading • For rated warranty, ambient temperature not to exceed 40°C (104°F) • Open-circuit protected output 	<p>HI-LUME SPEC SHEET</p> <p>HI-LUME PREMIERE SPEC SHEET</p> <p>INSTALLATION INSTRUCTIONS</p>
<p>eldoLED DALI/DMX Dimmable Drivers</p> 	<ul style="list-style-type: none"> • Available in linear or rectangular format • 100W, DMX/DALI interface • 4 control channels • 24V constant voltage, 4 x 24V outputs • Metal or plastic case options 	<p>100 W SPEC SHEET</p> <p>INSTALLATION INSTRUCTIONS</p>

Controllers

Item	Specifications	Downloads
<p>eldoLED Controllers</p> 	<p>180/D DMX Controller for RGB and Tunable White Applications</p> <p>210/D Dali Controller for Static White, RGB and Tunable White Applications</p> <p>211/D-LG 0-10V Logarithmic Dimming Controller</p> <p>211/D-LN 0-10V Linear Dimming Controller</p> <p>212/D DMX Controller for Static White and Static Color Applications</p> <p>DimWheel DMX Wall Controller for RGB/W and Tunable White Applications</p>	<p>180/D SPEC SHEET</p> <p>210/D SPEC SHEET</p> <p>211/D-LG SPEC SHEET</p> <p>211/D-LN SPEC SHEET</p> <p>212/D SPEC SHEET</p> <p>DIM WHEEL SPEC SHEET</p>

Click for more information

[INSTALLATION](#) [IES FILES](#) [DRIVERS & CONTROLS](#)