

INSTALLATION INSTRUCTIONS

MODELS: VarioContour 2000 Aluminum Profile

LED LINEAR™
lighting solutions

ATTENTION

Please read all safety and assembly instructions prior to installation and keep for future reference.

1. Product should be installed by a qualified electrician with regards to all applicable electrical and safety standards.
2. Ensure power is shut off at the electrical panel prior to installation in order to prevent electrical shock.
3. Use only with SELV (Safety Extra Low Voltage)/Class 2 power supplies.
4. Suitable for installation in Dry Locations.
5. Avoid looking directly into the light source during operation - glare hazard.
6. Do not store packed units over 70° F and over 50% humidity more than 12 months.



NOTE

Prior to installation, always test the LED tape with a suitable power supply in order to confirm operation and that the factory connections are secure. LED Linear only honors warranty for supplied material and is not liable for installation errors.

ALUMINUM PROFILE INSTALLATION

1 Preparing the Surface

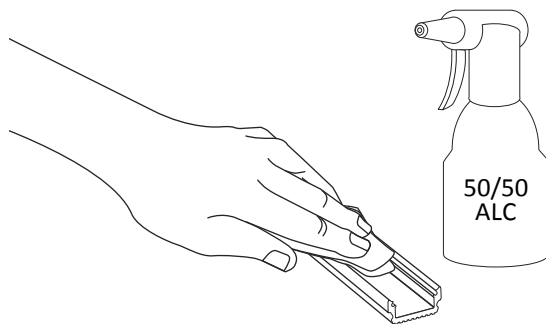

Thoroughly clean the area where tape lights will be installed. Using a 50/50 alcohol mix, clean the area where LEDs will be applied and allow time for alcohol to dry for 5 minutes.

2 Measuring

Measure and then mark the reference points

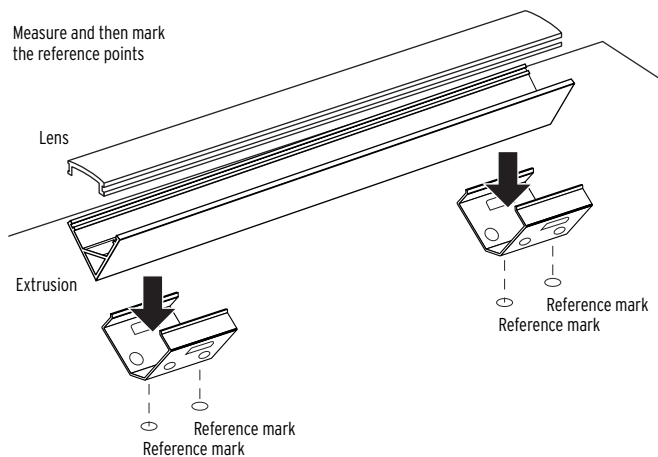

Align the mounting channel to the determined location. Mark reference points to install to the surface. The location of the power supply or wiring box should be determined prior to installation.

3 Brackets

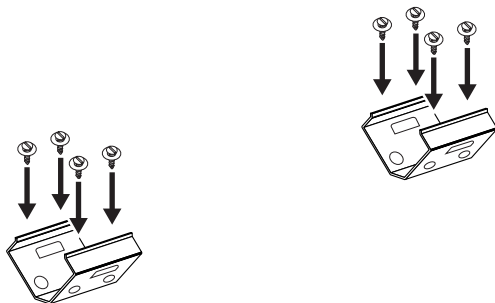

Screw the brackets to the desired surface.

4 Profile

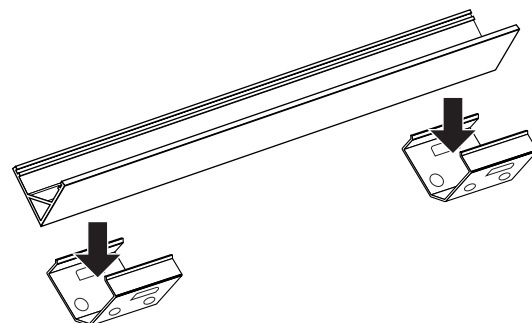

Clip the profiled bar into the brackets.

INSTALLATION INSTRUCTIONS

MODELS: VarioContour 2000 Aluminum Profile

LED LINEAR™
lighting solutions

ATTENTION

Please read all safety and assembly instructions prior to installation and keep for future reference.



5 LED Strip

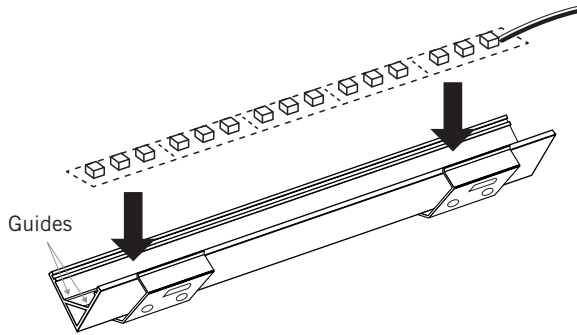

Press and glue the LED Strip Tape into place following the guides. Will accept a 14 mm wide strip maximum.

6 Lens

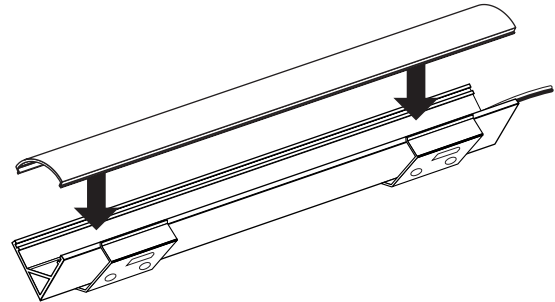

Clip the lens into place.

7 Endcaps

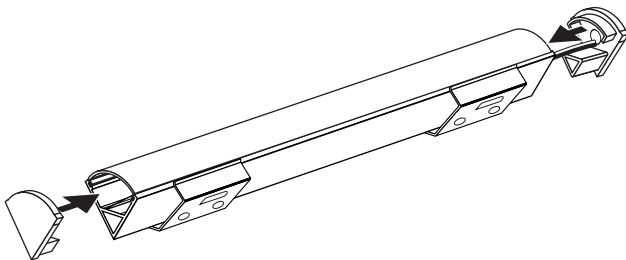

Feed the lead wires through the endcap. Apply glue to the inner part of the endcaps. Slide and press the endcaps into place.

8 Powering

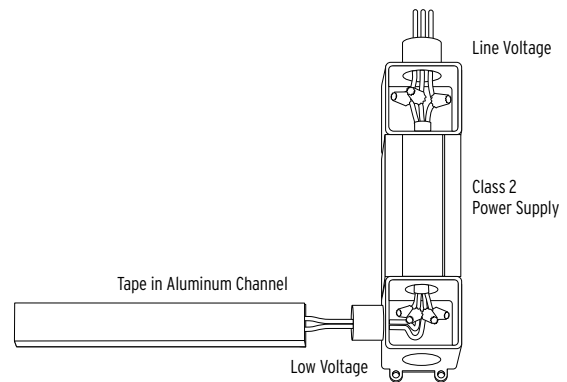

Ensure the correct (wattage & voltage) power supply is used to power the tape. Then proceed to connect low voltage wires from extrusion to power supply. For more information please refer to power supply and LED tape wiring instructions.